

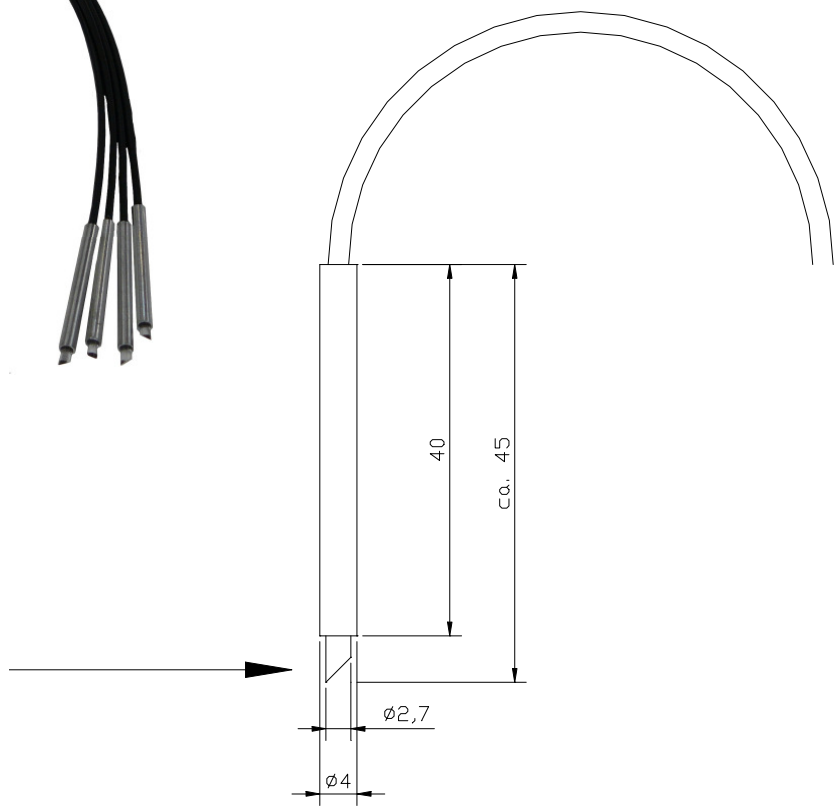

PR-LL-K1-500-4-W

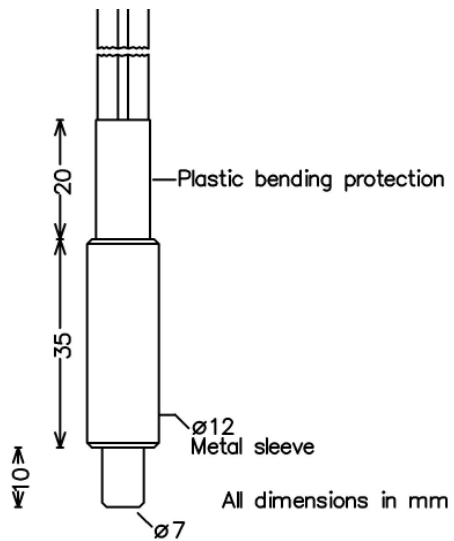

Bezeichnung	Lichtleiter Plastik
Typ	PR-LL-K1-500-4-W
Länge	1000, 2000mm
Anschluss	SMA-Stecker
Durchmesser Lichtleiter	1mm (16x250um)
Öffnungswinkel	60 Grad
Material Lichtleiter	Kunststoff POF
Material Ummantelung	Kunststoff
Biegeradius	Min. 50mm
Temperatur im Betrieb	-10 bis +60 Grad
Einsetzbar mit	VE0006, PR0062, MELOT-...-G

Description	Light Guide Plastic
Type	PR-LL-K1-500-4-W
Length	1000, 2000mm
Connector	SMA-Plug
Diameter Light guide	1mm (16x250um)
Aperture Angle	60 Degree
Material Light Guide	Plastic POF
Material Shielding	Plastic
Bending Radius	Min. 50mm
Operating Temperature	-10 to +60 Degree
Applicable to	VE0006, PR0062, MELOT-...-G